

Nonsense Songs



Create your very own nonsense poem or song!

Write out some random words and/or cut words out of old magazines and flyers



Put all of your words into a pot

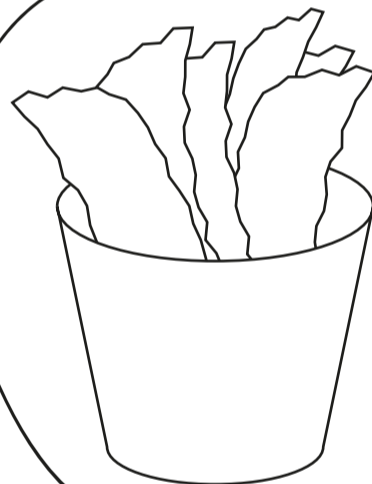

Select 10-15 words - you can choose not to look or peek if you don't want to

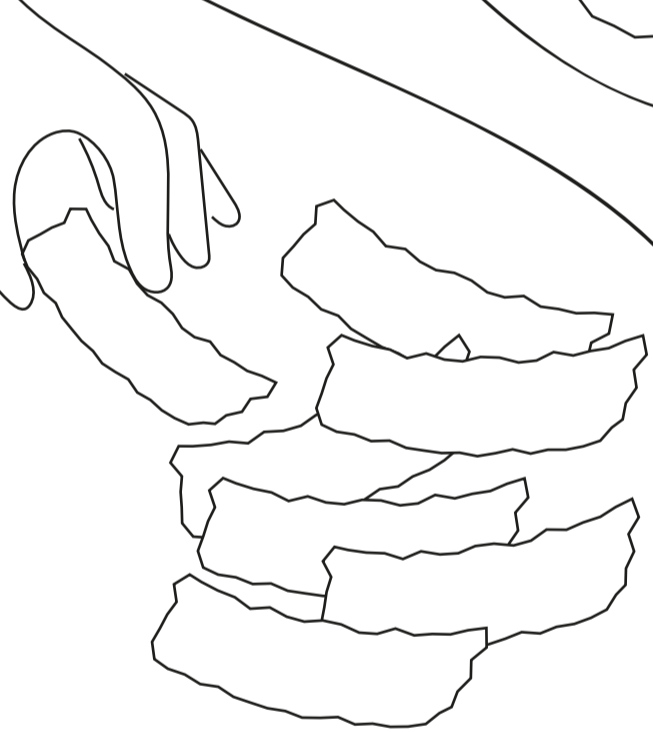

Assemble your words into a nonsense song or poem!

BRIGHT
AND
HOME
FOR
JUST
COOKING
CLOUDS
AND
PARTY

Pyka Loop Track

Download the
Pyka Loop app

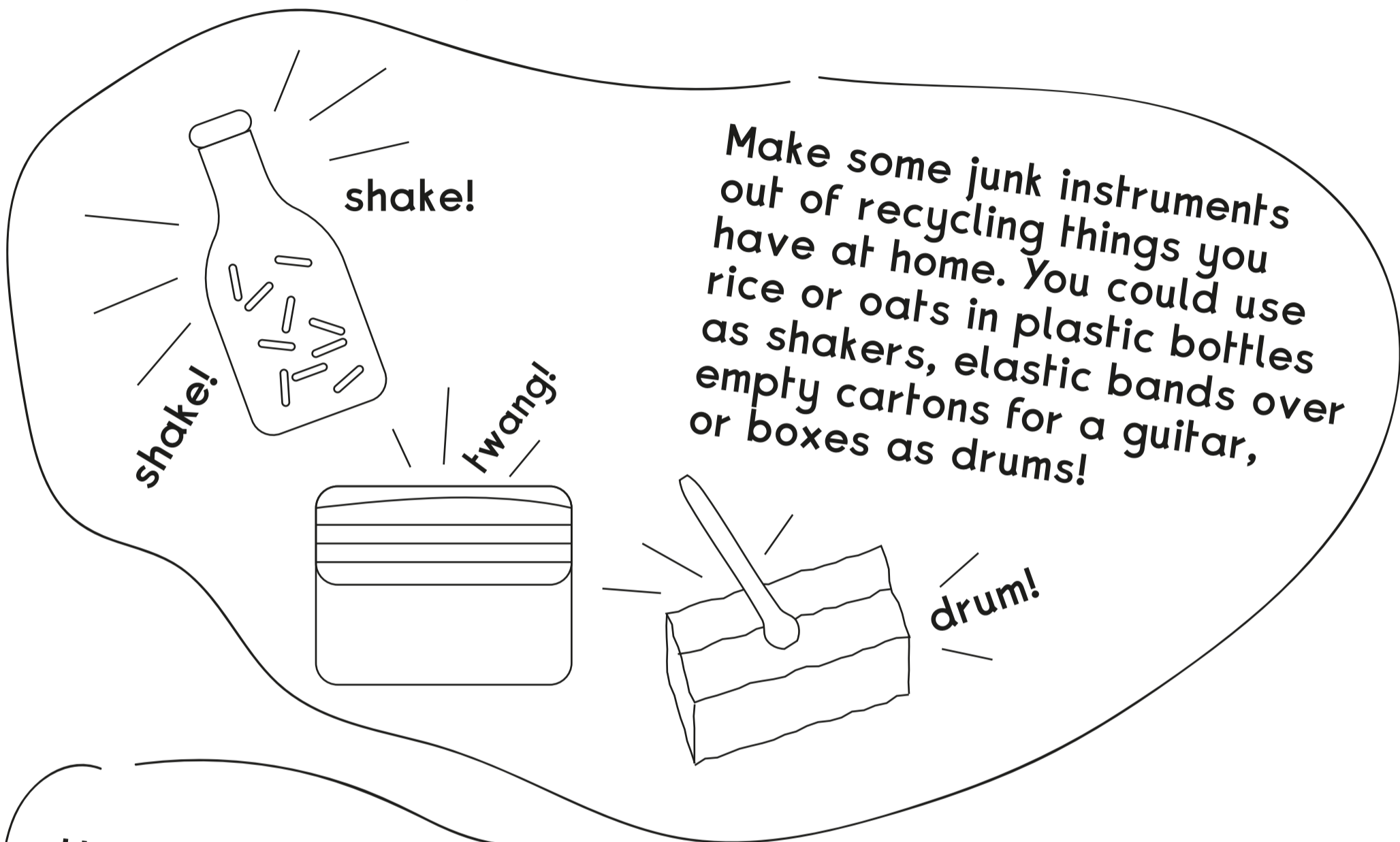
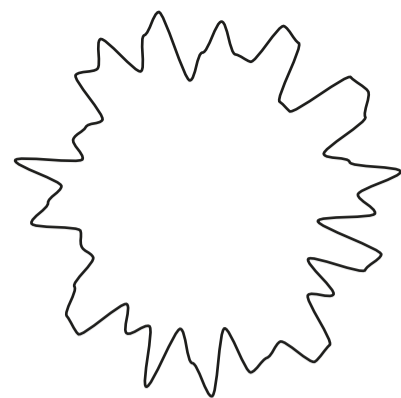
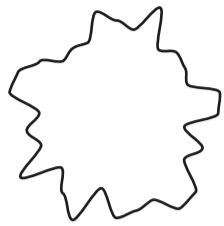

Use Pyka Loop to record your instrument sounds, and maybe add some words too!

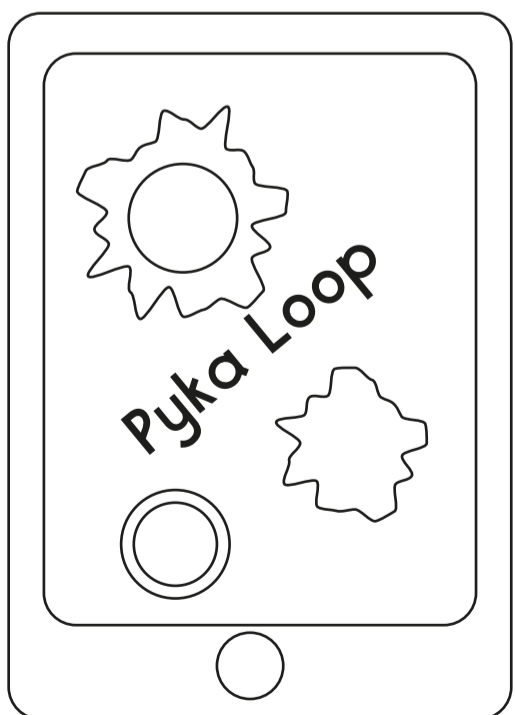

recording

Use the app to layer the sounds, and you have created your own track!

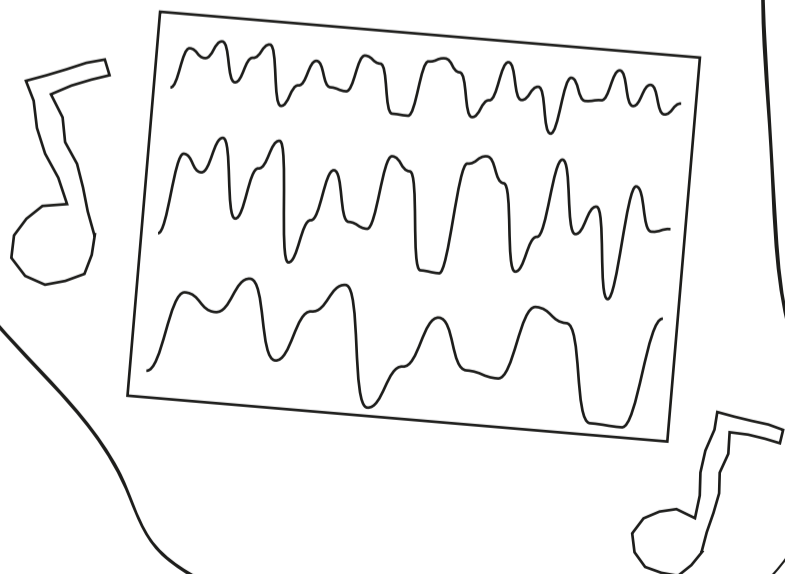

Mystery drawings ? ? ?

Ask a grown up to collect some safe, random objects from around the house and put them in a box. Some ideas include kitchen utensils and fruit!

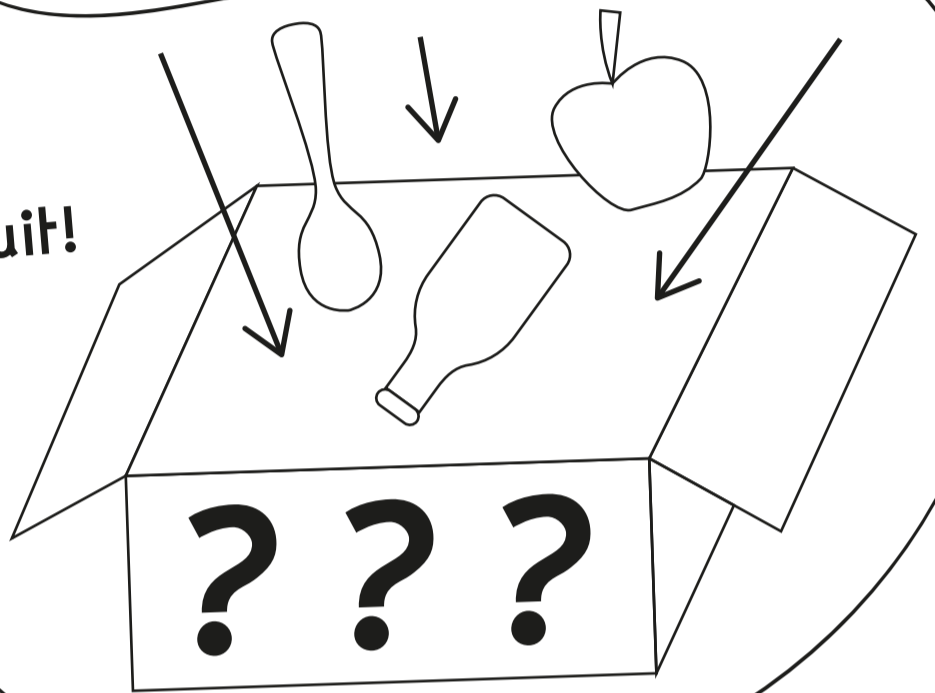

Sit down with pens/crayons and paper directly in front of you, then put a blindfold on - this could be a scarf wrapped around your head!

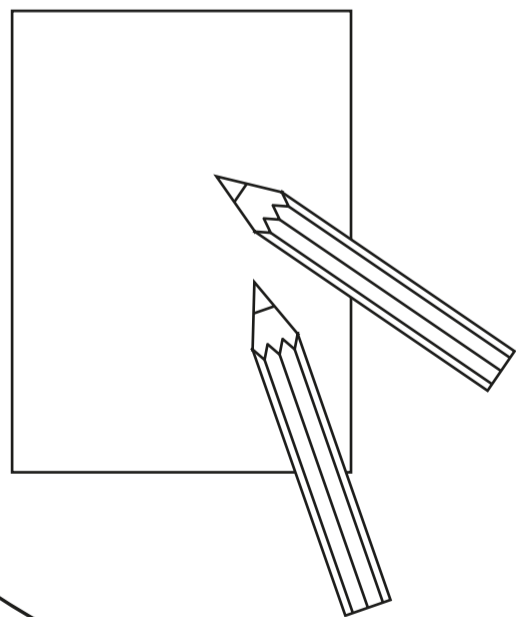
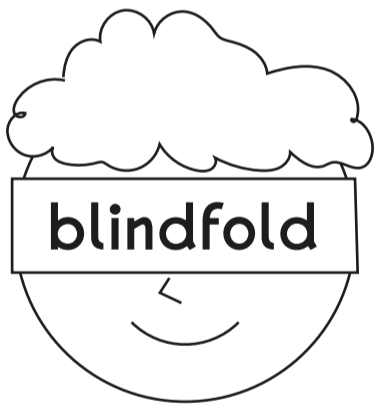

Ask a grown up to put the box next to you and then pick out a mystery object. Try to draw it without looking, just by feeling it! What does it feel like? Is it soft, hard, furry, cold or warm?

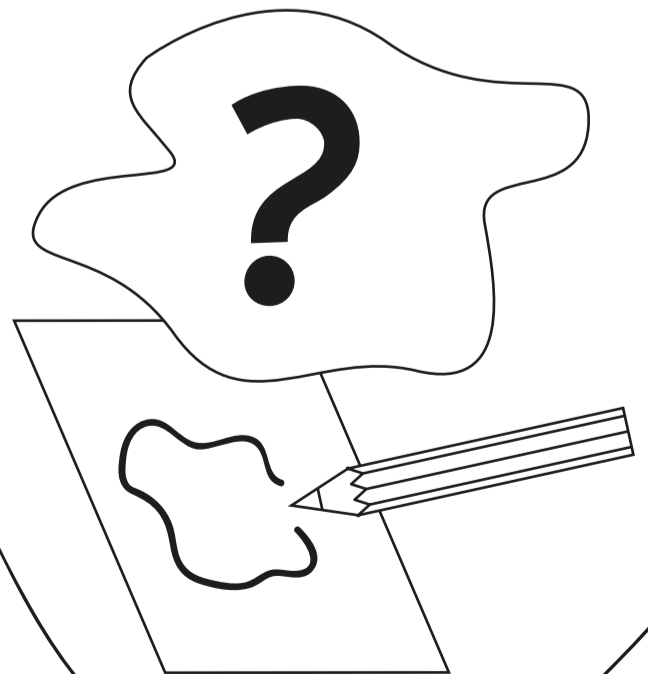

What interesting results have you got?

Drawing Tastes

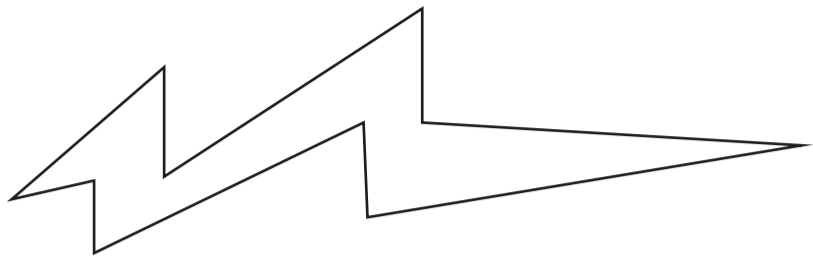

Ask a grown up to prepare some snacks for you



Use felt tips/ crayons to try and draw the tastes of your food- chew slowly!

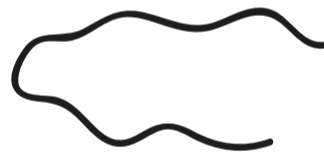
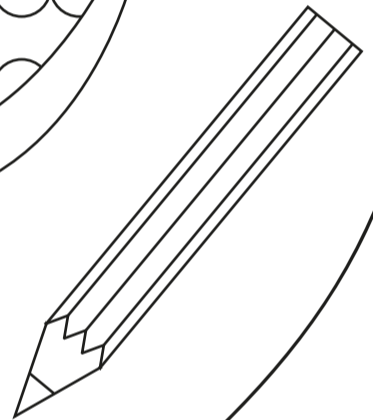
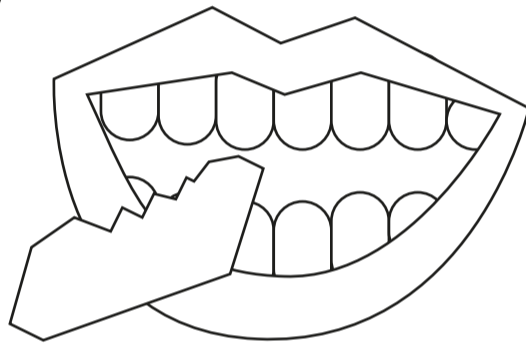

Is it fresh, hot, cold or spicy? Use your imagination to represent the flavours in shapes and colours!

